

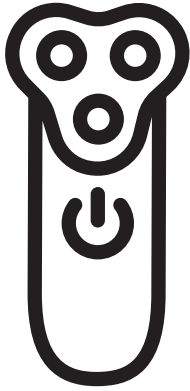



PHILIPS

S3000



www.philips.com/support

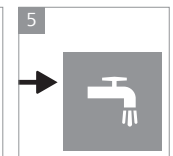
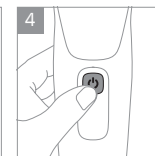
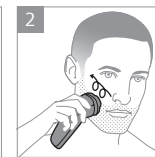
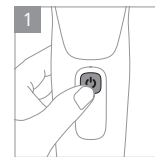
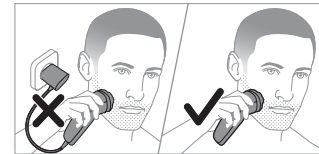
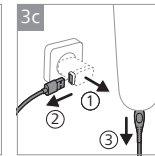
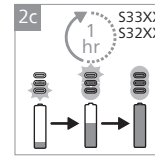
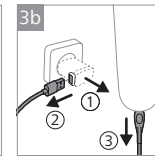
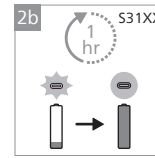
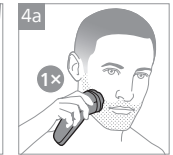
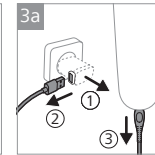
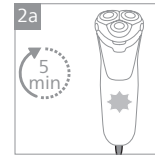
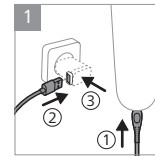
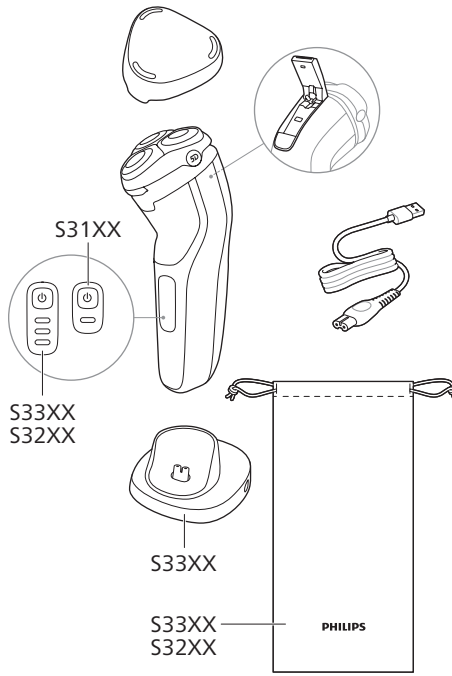

© 2022 Koninklijke Philips N.V.  
All rights reserved  
3000.105.8952.1 (22/12/2022)  
>75 % recycled paper  
>75 % papier recycle



