

43"/50"
55"/65"

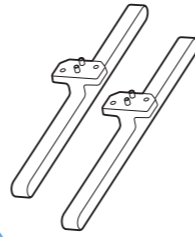

75"

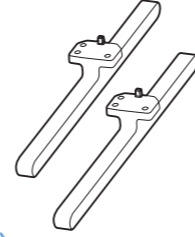

43" (Q4xL16) x 4
50"/55" (Q4xL18) : x4
65" (M4xL20) : x4
75" (M5xL22) : x6

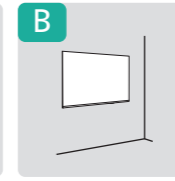
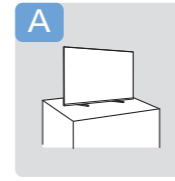

Register to find out more and get support
www.philips.com/TVsupport

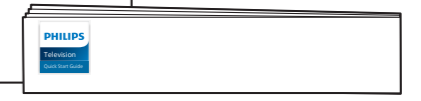
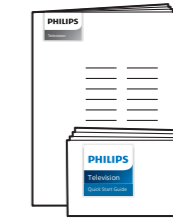
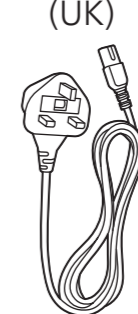
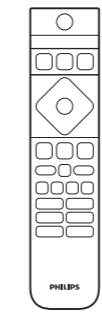
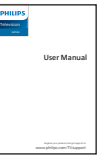
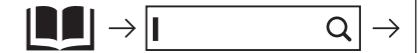

A

43"/50"/55"

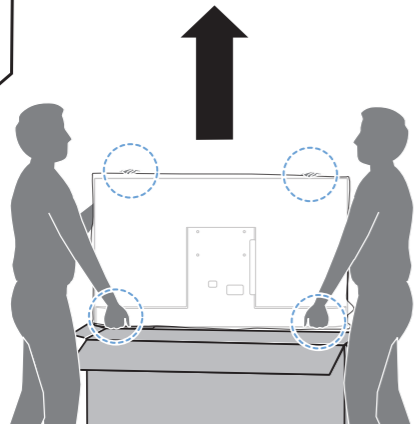
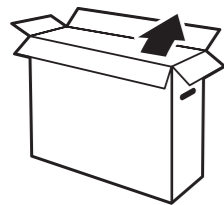

65"

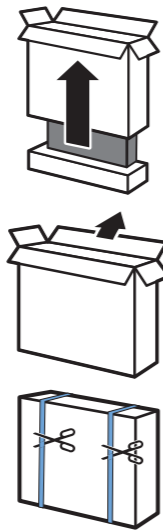

75"

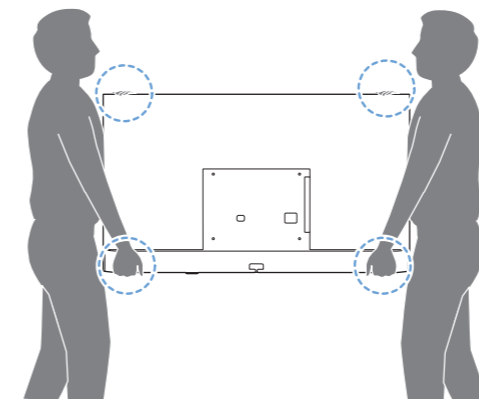
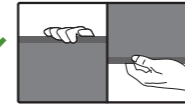
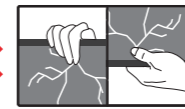
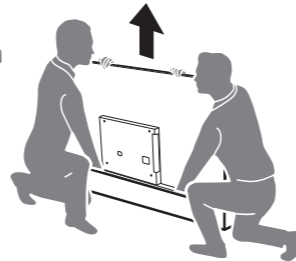
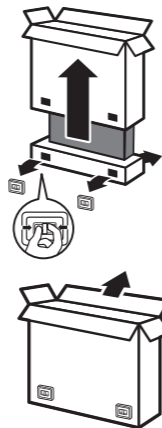

1

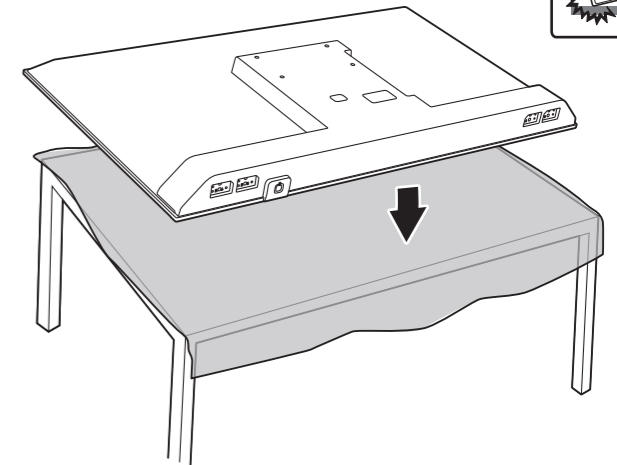

2

43"/65"/75"

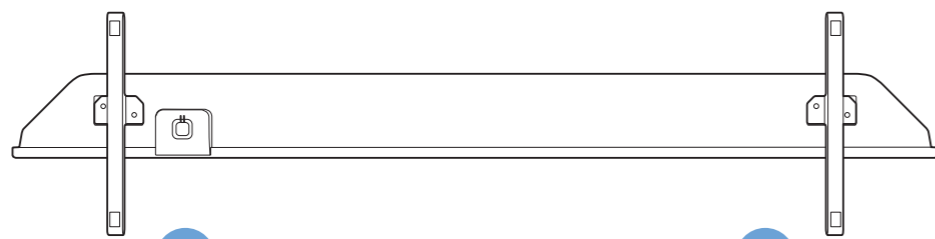

R + L

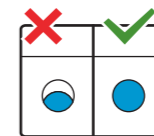

50"/55"

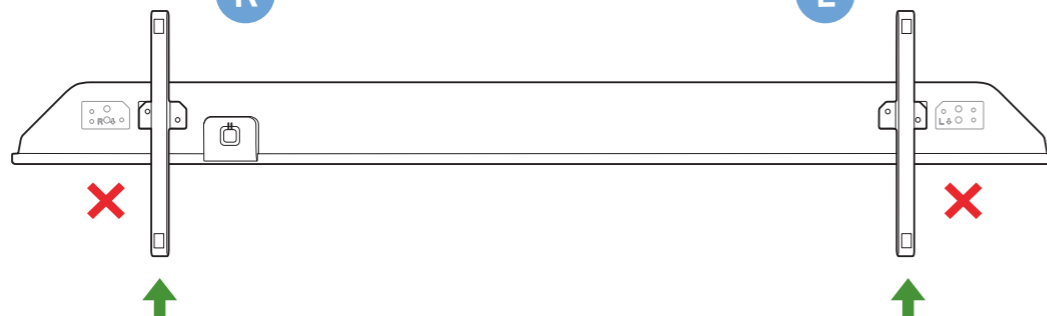

43"/50"
55"/65"

75"

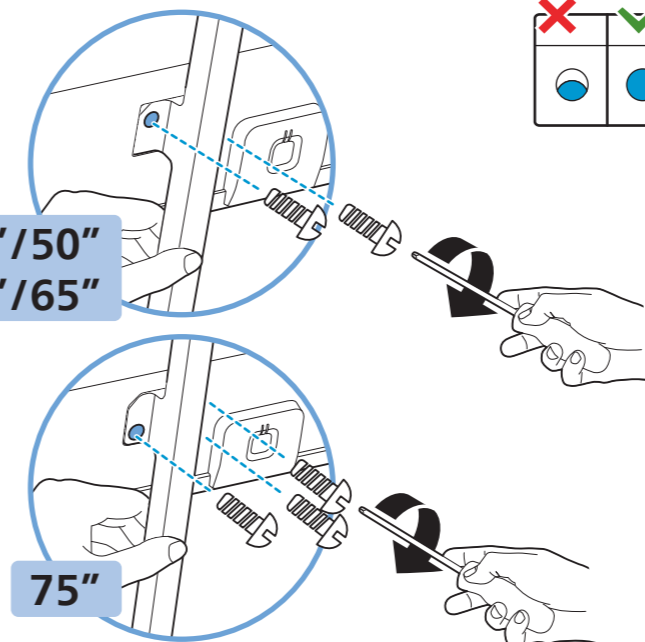

3

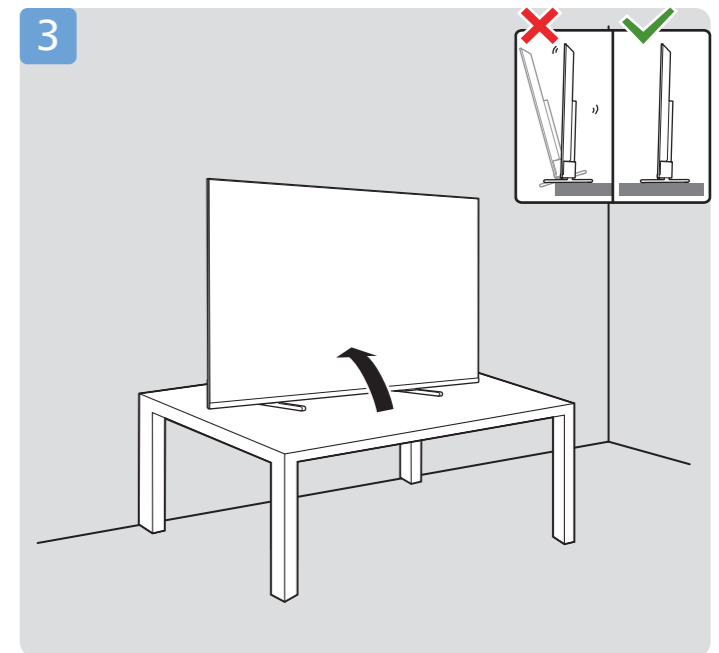
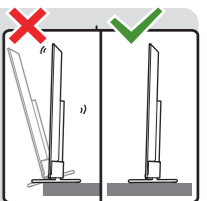

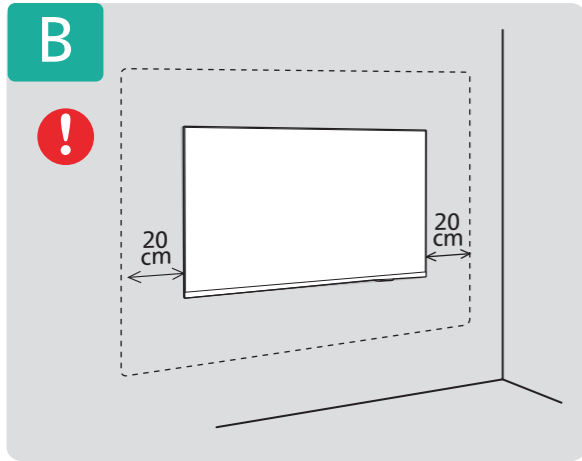

English Read the safety instructions.
Български Прочетете инструкциите за безопасност.
Čeština Přečtěte si bezpečnostní pokyny.
Hrvatski Pročitajte sigurnosne upute.
Dansk Læs sikkerhedsforskrifterne.
Deutsch Lesen Sie die Sicherheitshinweise.
Ελληνικά Διαβάστε τις οδηγίες ασφαλείας.
Eesti Lugege ohutusnõudeid.
Español Lea las instrucciones de seguridad.

Français Lisez les consignes de sécurité.
Italiano Leggere le istruzioni di sicurezza.
Қазақша Қорғаныстық нұсқаулар.
Latviešu Izlasiet drošības norādījumus.
Lietuvių Perskaitykite saugos instrukcijas.
Magyar Olvassa el a biztonsági utasításokat.
Nederlands Lees de veiligheidsvoorschriften.
Norsk Les sikkerhetsforskriftene.
Polski Zapoznaj się z instrukcjami bezpieczeństwa.

Português Leia as instruções de segurança.
Română Citiți instrucțiunile de siguranță.
Русский Читайте инструкции по технике безопасности.
Srpski Pročitajte bezbednosna uputstva.
Slovenščina Preberite varnostna navodila.
Slovenský Prečítajte si bezpečnostné pokyny.
Suomi Lue turvaohjeet.
Svenska Läs säkerhetsinstruktionerna.
ภาษาไทย โปรดอ่านคำแนะนำด้านความปลอดภัย

Türkçe Güvenlik talimatlarını okuyun.
Українська Читайте інструкції з техніки безпеки.
العربية قراءة تعليمات السلامة.
עברית קראו את הוראות הבטיחות

FSC Logo
H:12mm



Wall Mount dimensions (x, y)
Dimensioni del montaggio a parete (x, y)

43" 200x100mm M6 (L: 8mm~10mm)



50" 200x100mm M6 (L: 8mm~10mm)



55" 200x100mm M6 (L: 8mm~10mm)



65" 400x300mm M8 (L: 12mm~22mm)



75" 400x300mm M8 (L: 12mm~22mm)

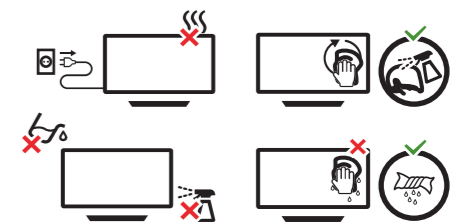
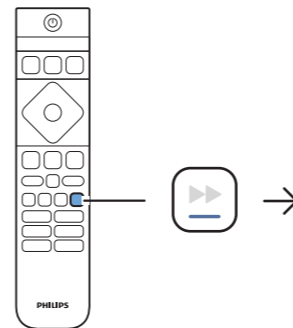
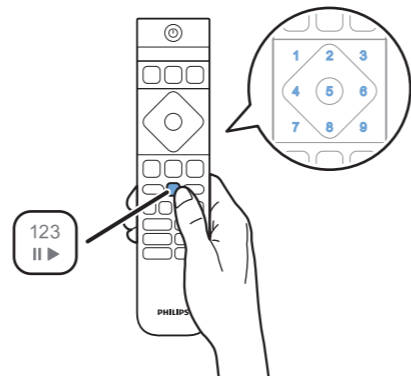
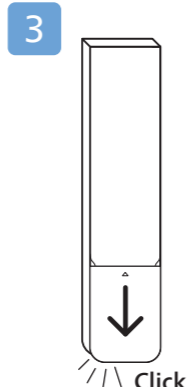
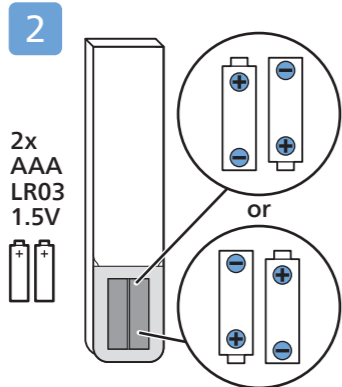
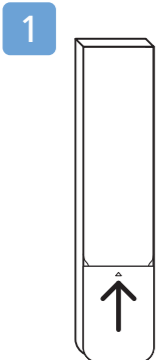
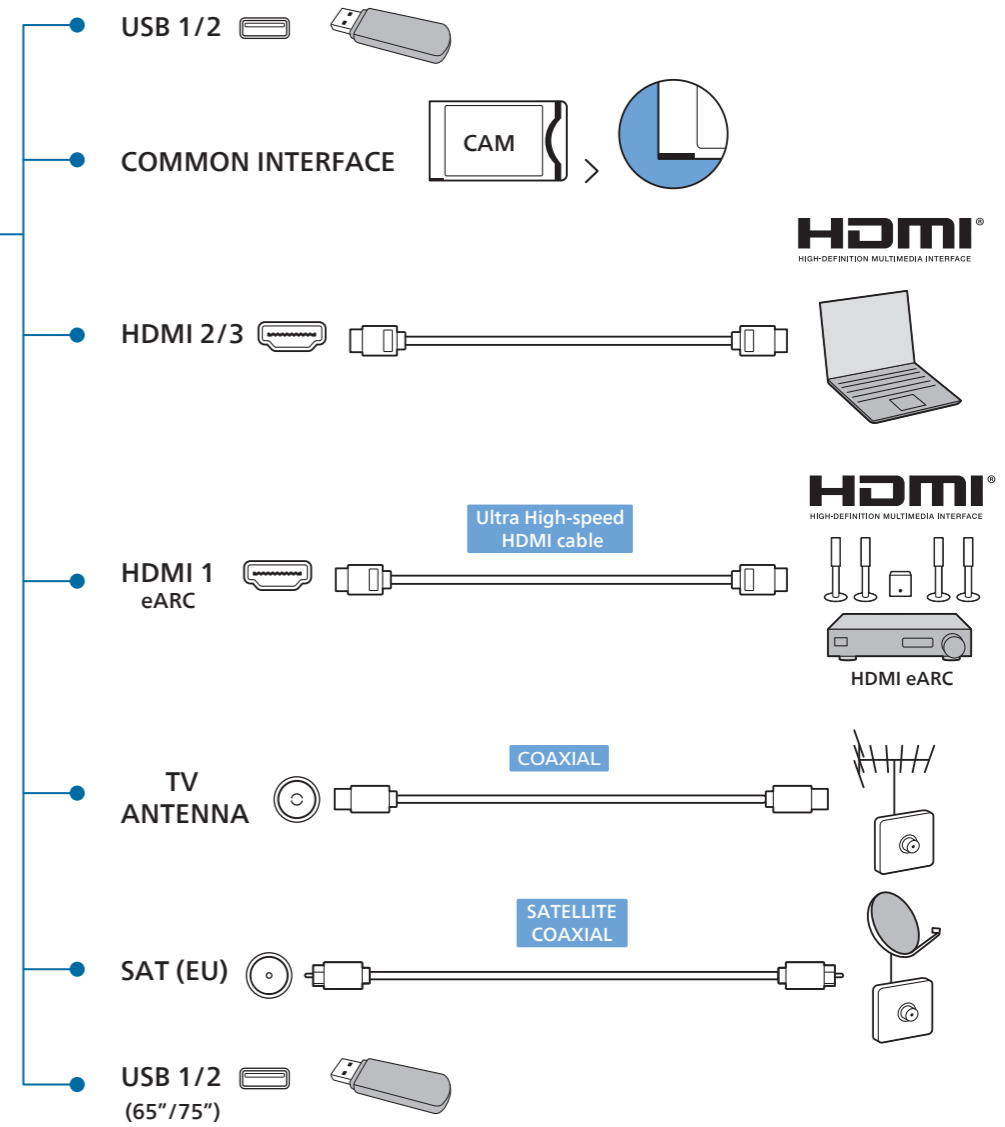
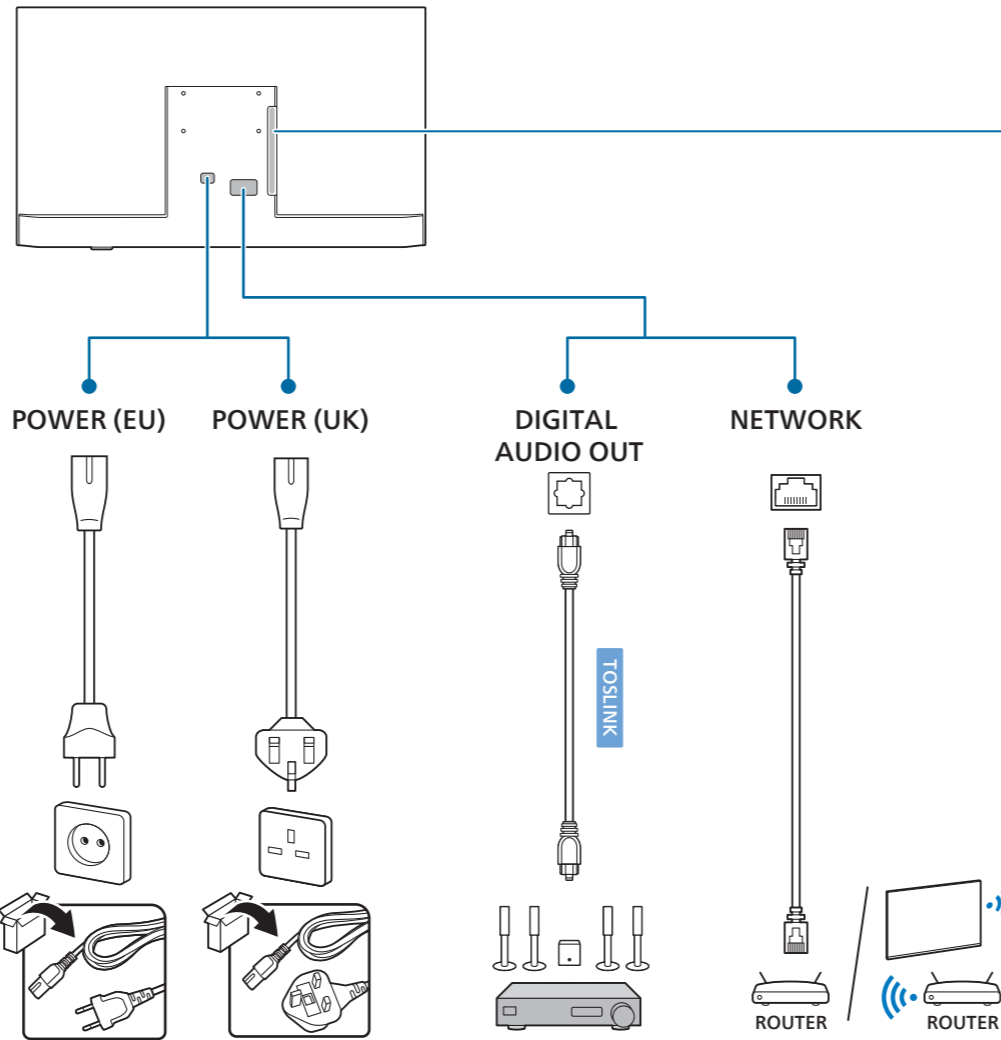
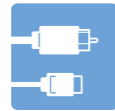

All registered and unregistered trademarks are property of their respective owners. Specifications are subject to change without notice. Philips and the Philips Shield Emblem are registered trademarks of Koninklijke Philips N.V. and are used under license. This product has been manufactured by and is sold under the responsibility of TP Vision Europe B.V., and TP Vision Europe B.V. is the warrantor in relation to this product. 2024 © TP Vision Europe B.V. All rights reserved. www.philips.com/welcome