ECAM22X.2Y - 22X.3Y

MAGNIFICA START

QUICK GUIDE



DeLonghi



DeLonghi



Per completare correttamente il primo avvio, la manopola deve essere in pos. 0 • Make sure the steam knob is on 0 pos. for the whole operation • Pour compléter correctement le premier démarrage, la manette doit être positionnée sur 0 • Um die erste Inbetriebnahme korrekt zu beenden, muss der Drehknopf auf Pos. 0 stehen • Om de eerste inwerkingstelling correct te voltooien, moet de knop geplaatst zijn op stand 0 • Para completar correctamente la primera puesta en funcionamiento, el mando debe estar en la pos. 0 • Para realizar correctamente o primeiro arranque, o manípulo deve estar na pos. 0 • Για να ολοκληρωθεί σωστά η αρχική εκκίνηση λειτουργίας, ο διακόπτης πρέπει να είναι στη θέση 0 • For å fullføre første oppstart korrekt må bryteren være i pos. 0 • För att fullborda den första starten korrekt, ska vredet vara i läge. 0 • For at gennemføre den første opstart korrekt skal knappen stå i pos. 0 • Jotta ensimmäinen käynnistys sujuisi oikeaoppisesti, nupin tulee olla asemissa 0 • Для правильного завершения первого запуска рукоятка должна быть в поз. 0 • Щоб правильно завершити налаштування машини, кнопки пари повинні бути в положенні «0» • Машинаны дұрыс орнату үшін бу беру тұтқасы "0" күйінде болуы керек. • Az első indítás sikeres elvégzése érdekében a szabályozó gombnak 0 • Pro správné dokončení prvního spuštění musí být knoflík v pol. 0 • Pre správne dokončenie prvého spustenia musí byť gombík v pol. 0 • Aby prawidłowo zakończyć pierwsze uruchomienie, pokrętko musi się znajdować w poz. 0 • Za ispravno dovršenje prvog pokretanja, ručica mora biti u poz. 0 • Da bi pravilno zaključili prvi zagon, mora biti ručica na pol. 0 • Za ispravno završetak prvog pokretanja, ručica mora da bude u pol. 0 • Asigurati-vă că butonul pentru abur este în poziția 0 • Переконайтеся, що ручка подачі пари знаходиться в положенні 0 • Pentru a finaliza corect prima punere în funcțiune, butonul rotativ trebuie să fie pe poz. 0 • İlk başlatmayı doğru şekilde tamamlamak için düğmenin 0 konumunda olması gerekir

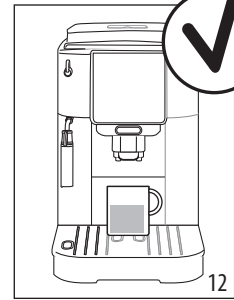
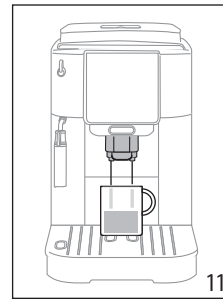
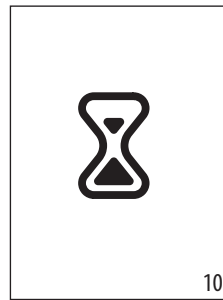
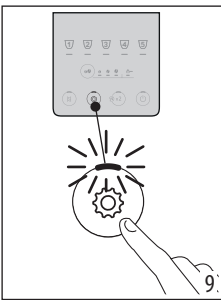
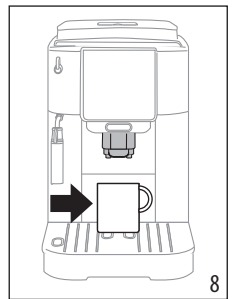
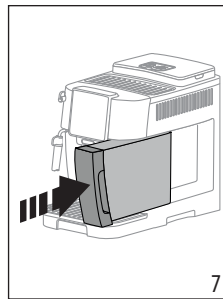
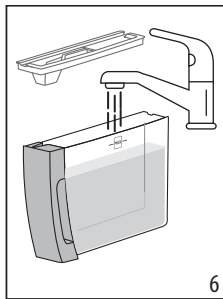
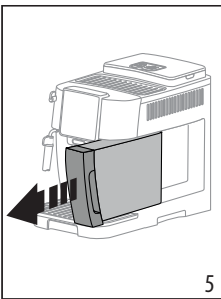
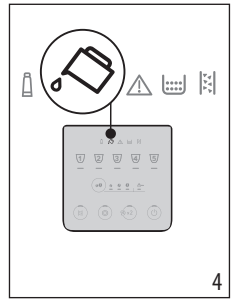
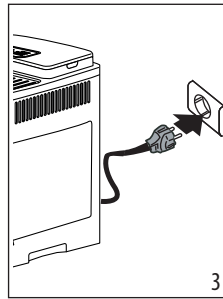
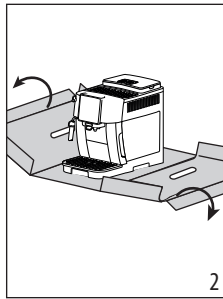
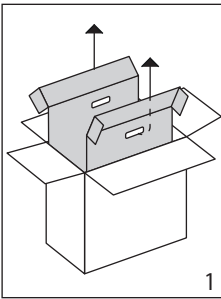

لإتمام بدء التشغيل الأول بطريقة صحيحة، يجب أن يكون المقبض في الموضع 0 • برای تکمیل صحیح تنظیمات دستگاه، گردونه بخار باید در حالت «0» قرار داشته باشد.

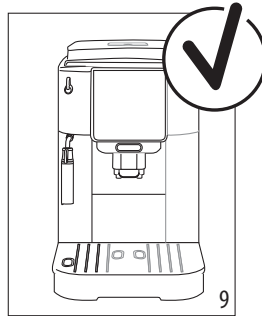
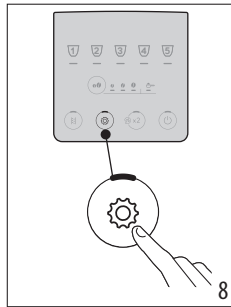
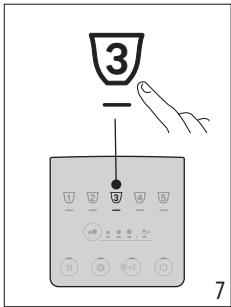
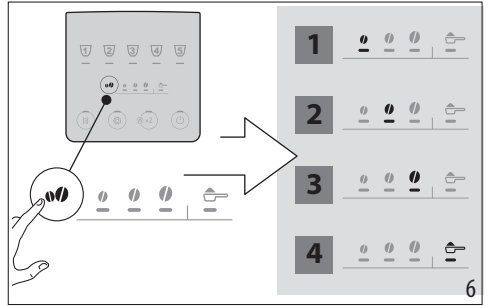
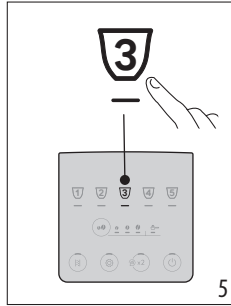
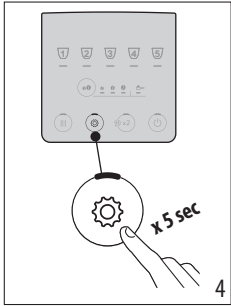
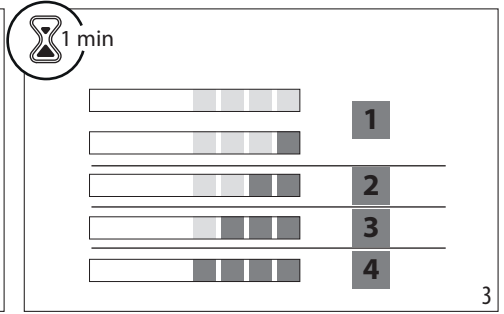
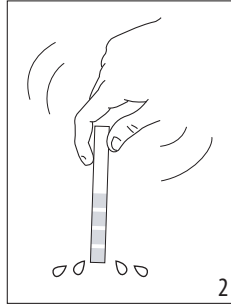
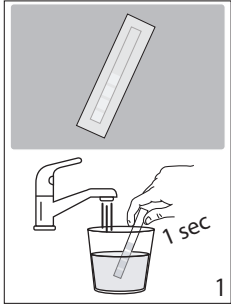

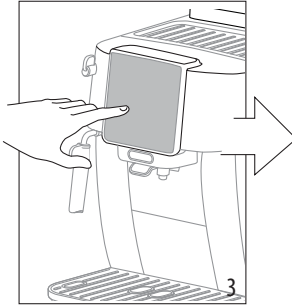
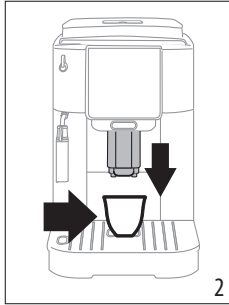
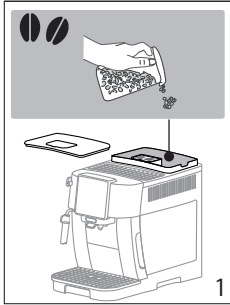



(*)

-  Espresso
-  Coffee
-  Long
-  Doppio+
-  Americano

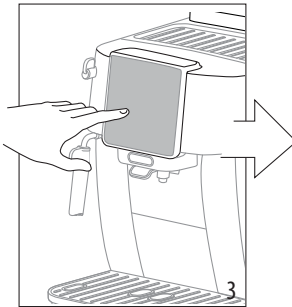
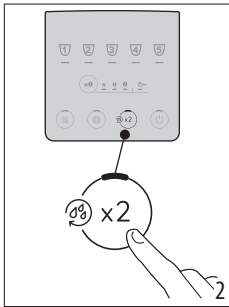
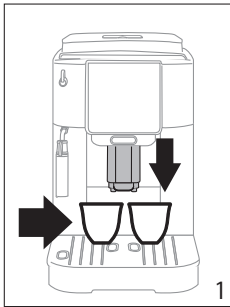
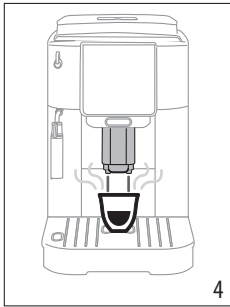

 Espresso

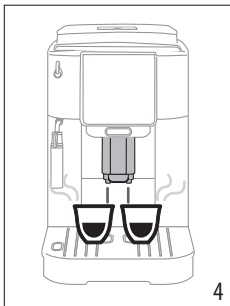

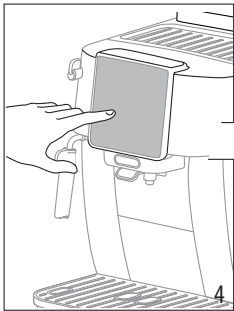
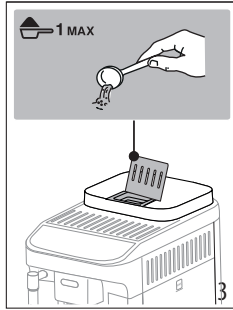
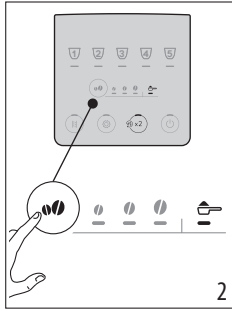
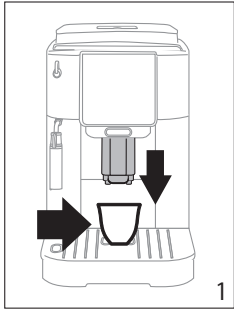

(*)

-  Espresso
-  Coffee
-  Long
-  Americano

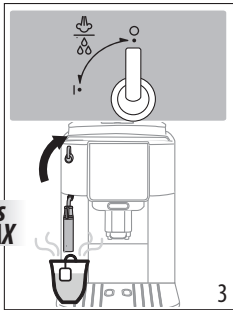
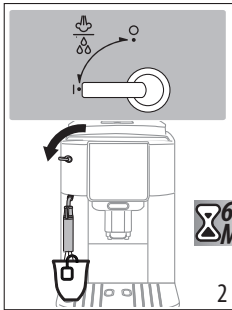
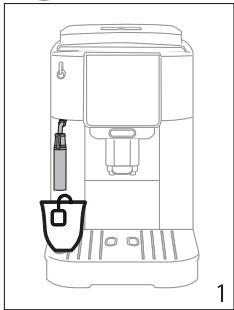
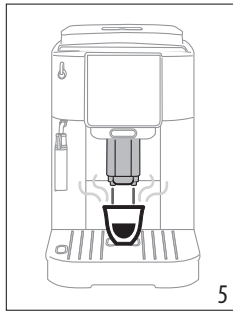

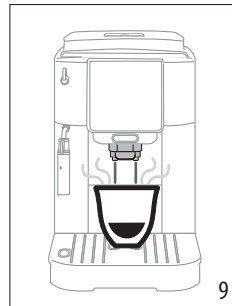
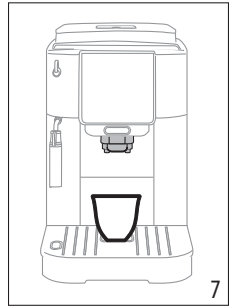
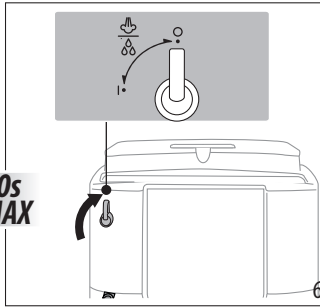
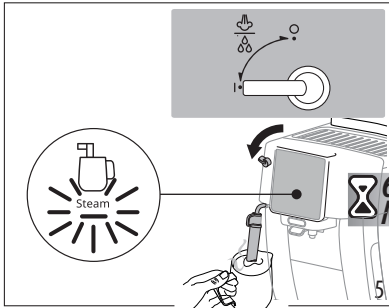
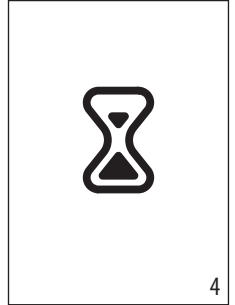
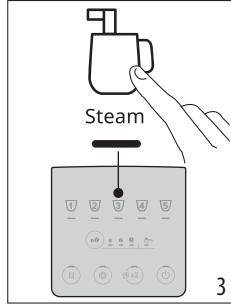
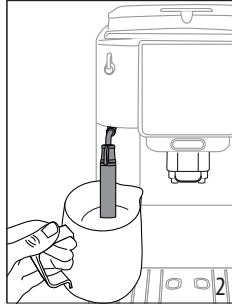
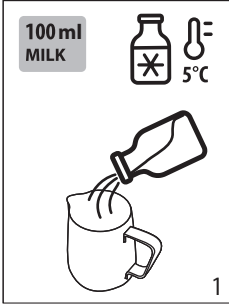



50°C	×	×	×	✓	✓
	✓	✓	✓	✓	✓

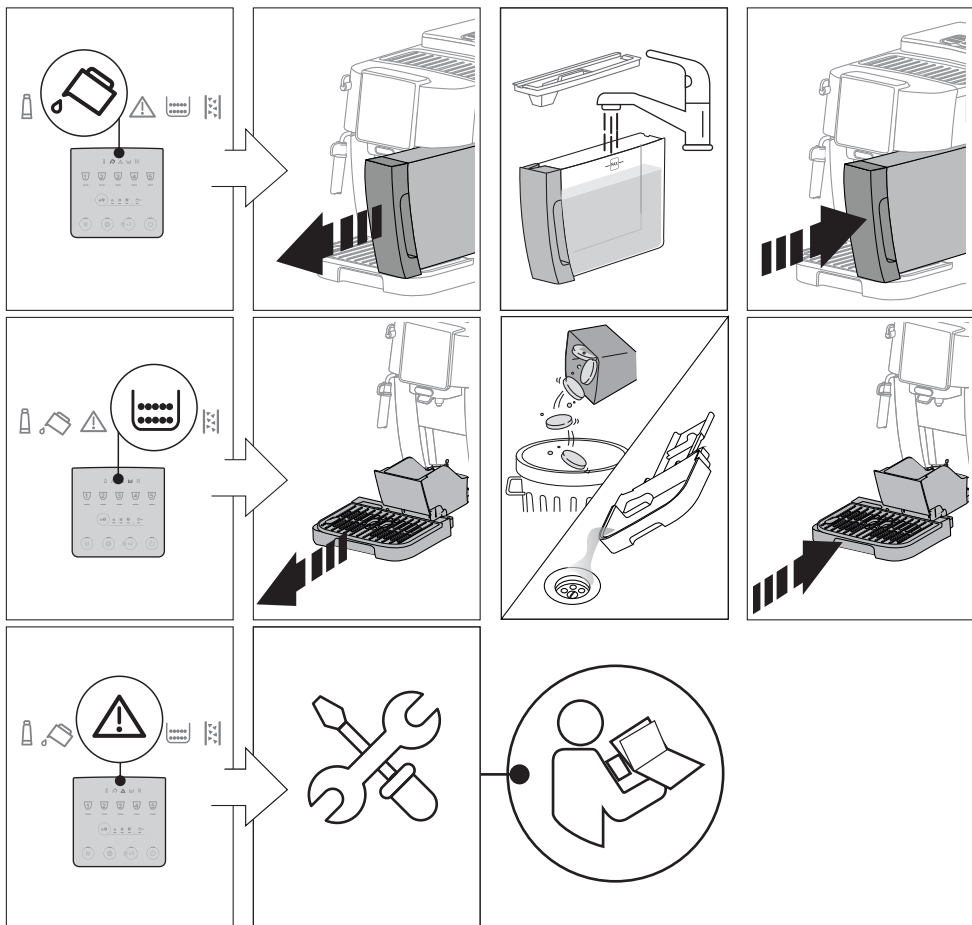



YouTube



DeLonghi

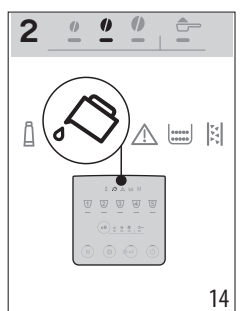
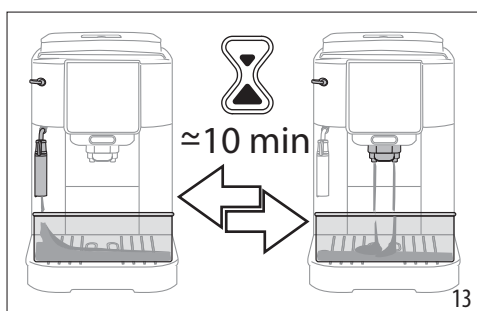
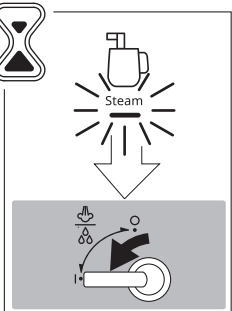
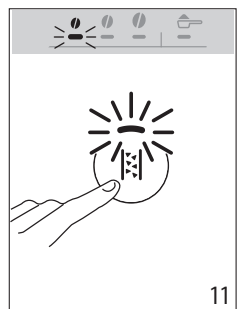
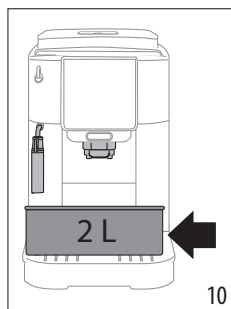
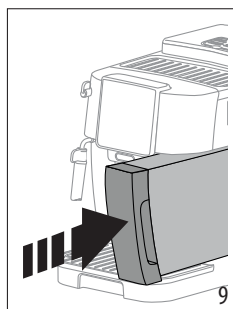
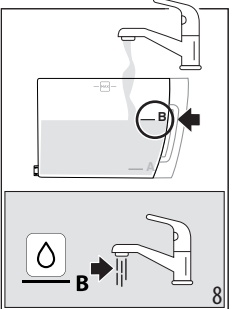
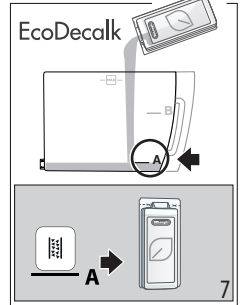
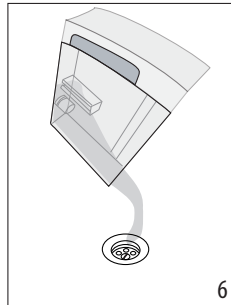
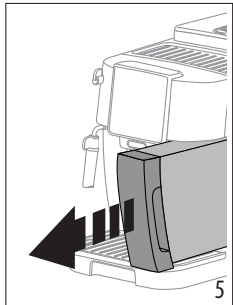
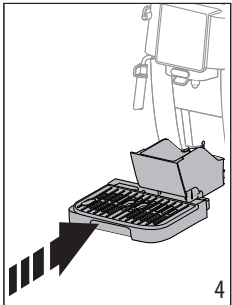
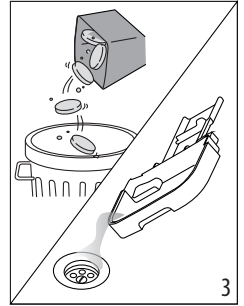
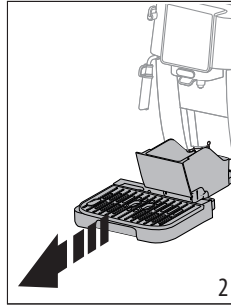
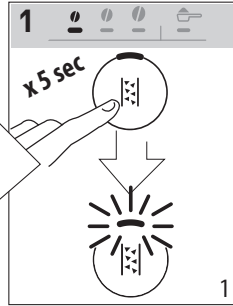
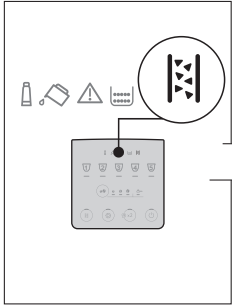

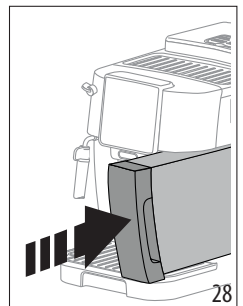
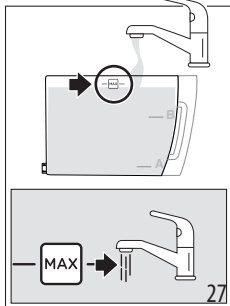
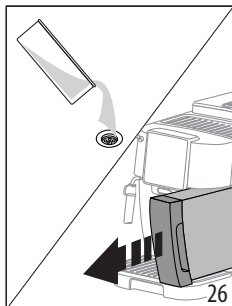
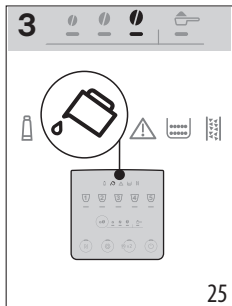
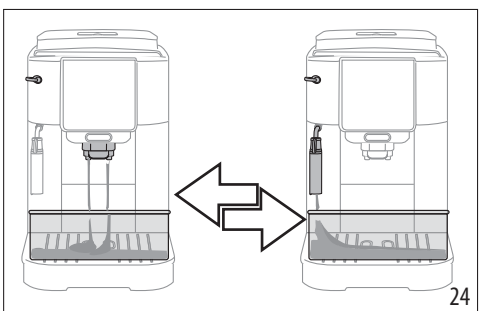
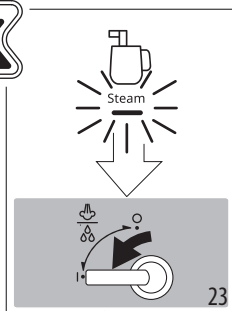
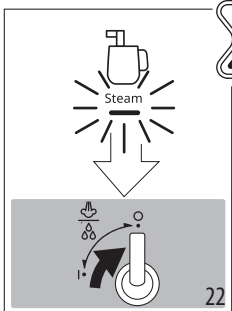
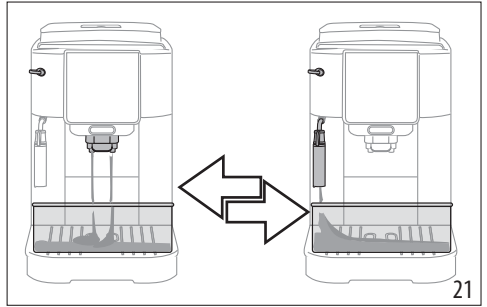
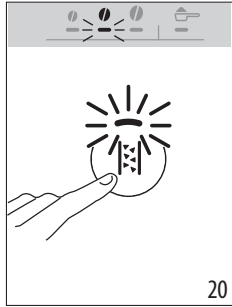
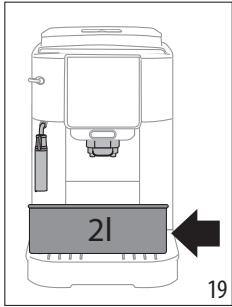
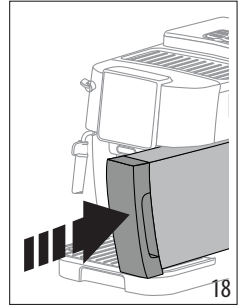
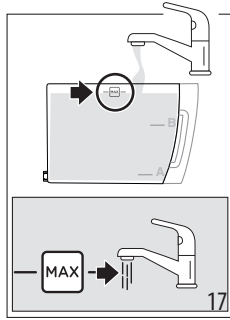
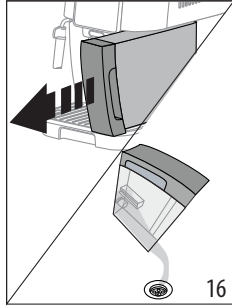
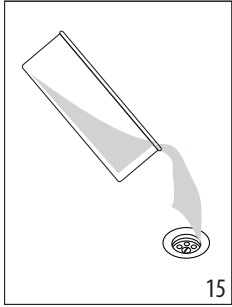

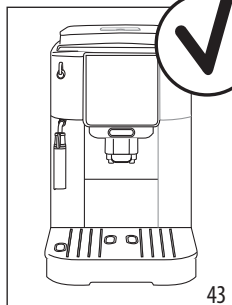
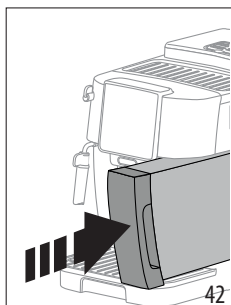
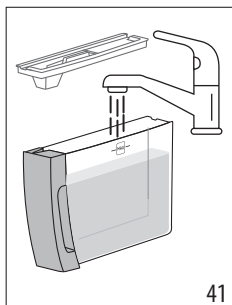
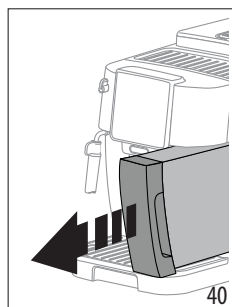
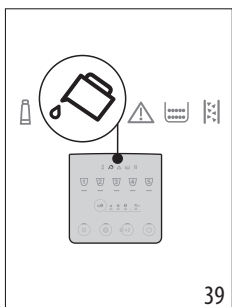
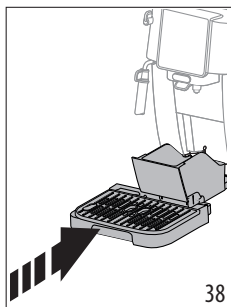
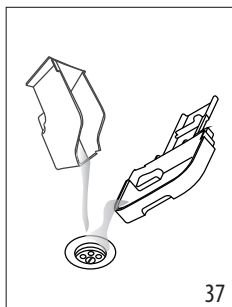
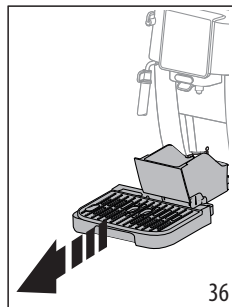
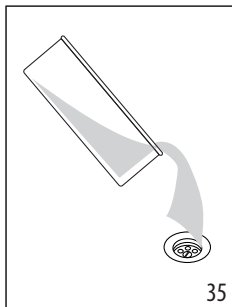
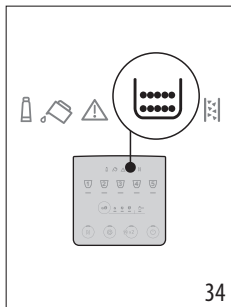
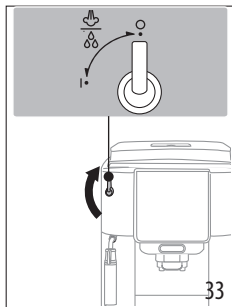
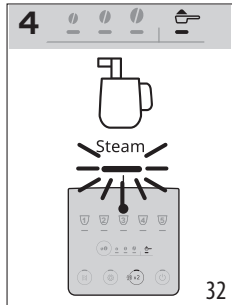
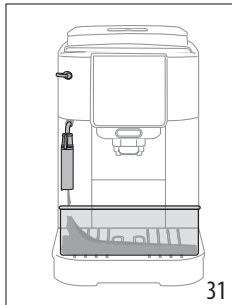
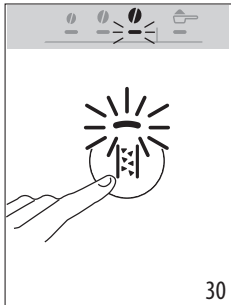
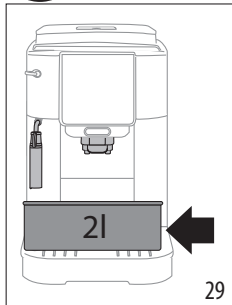

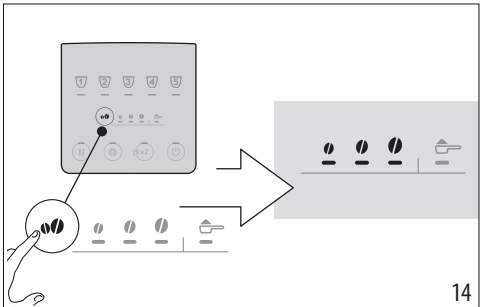
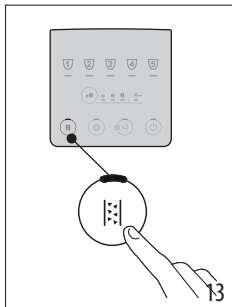
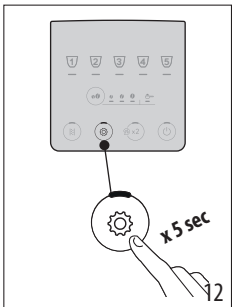
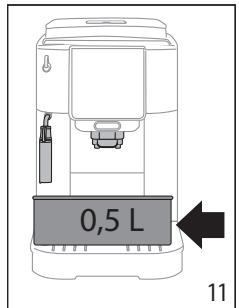
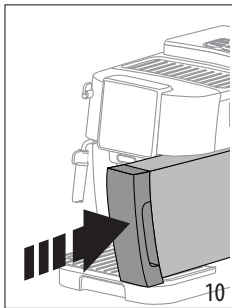
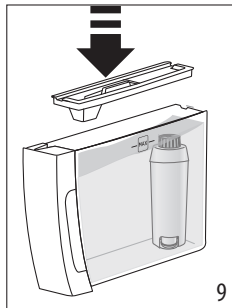
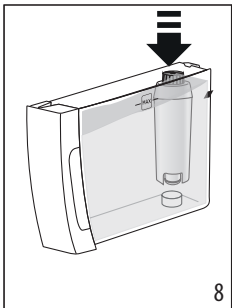
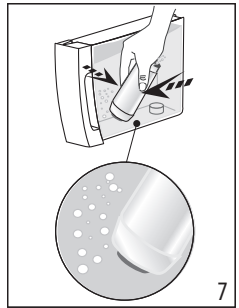
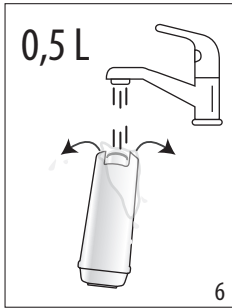
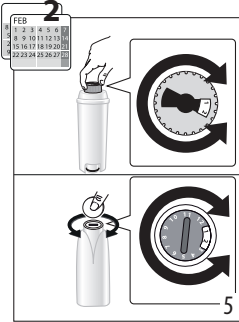
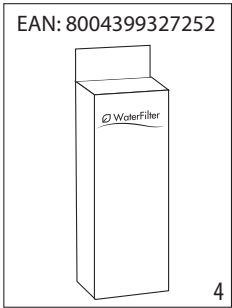
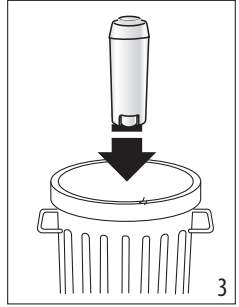
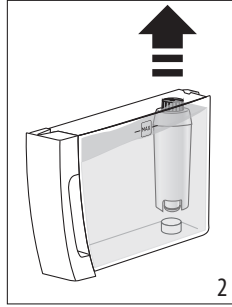
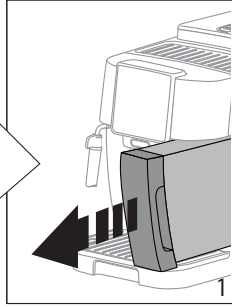
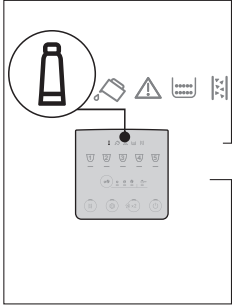

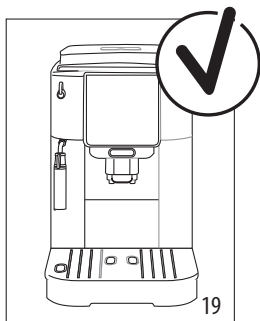
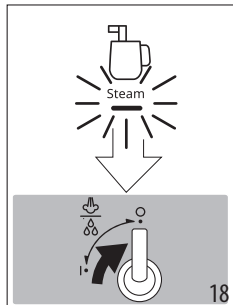
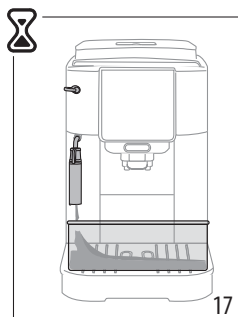
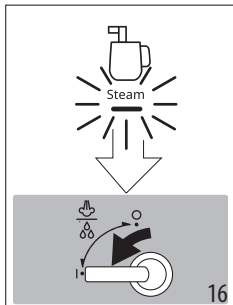
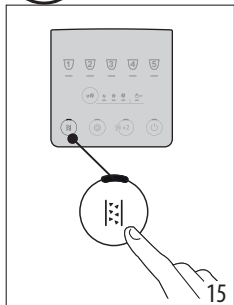

~ 220-240 V 50-60 Hz 1450 W

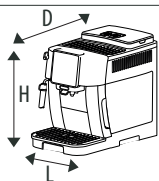

(LxDxH): 240 x 440 x 350 mm

8,8 Kg

 YouTube



More instructions available here



Register Now

www.delonghi.com/register



De'Longhi Appliances via Seitz, 47 31100 Treviso, Italy www.delonghi.com

57132C7931_01_0522